

MAXIBURST 40 JAW ASSEMBLY (4 Bolt)

1. Upper Jaw Block
2. Lower Jaw Block
3. Jaw Block Inserts
4. Jaws
5. Jaw Pin
6. Jaw Spring
7. Spring Retaining Bolt
8. Jaw Bolt
9. Jaw Block Bolt
10. Brake

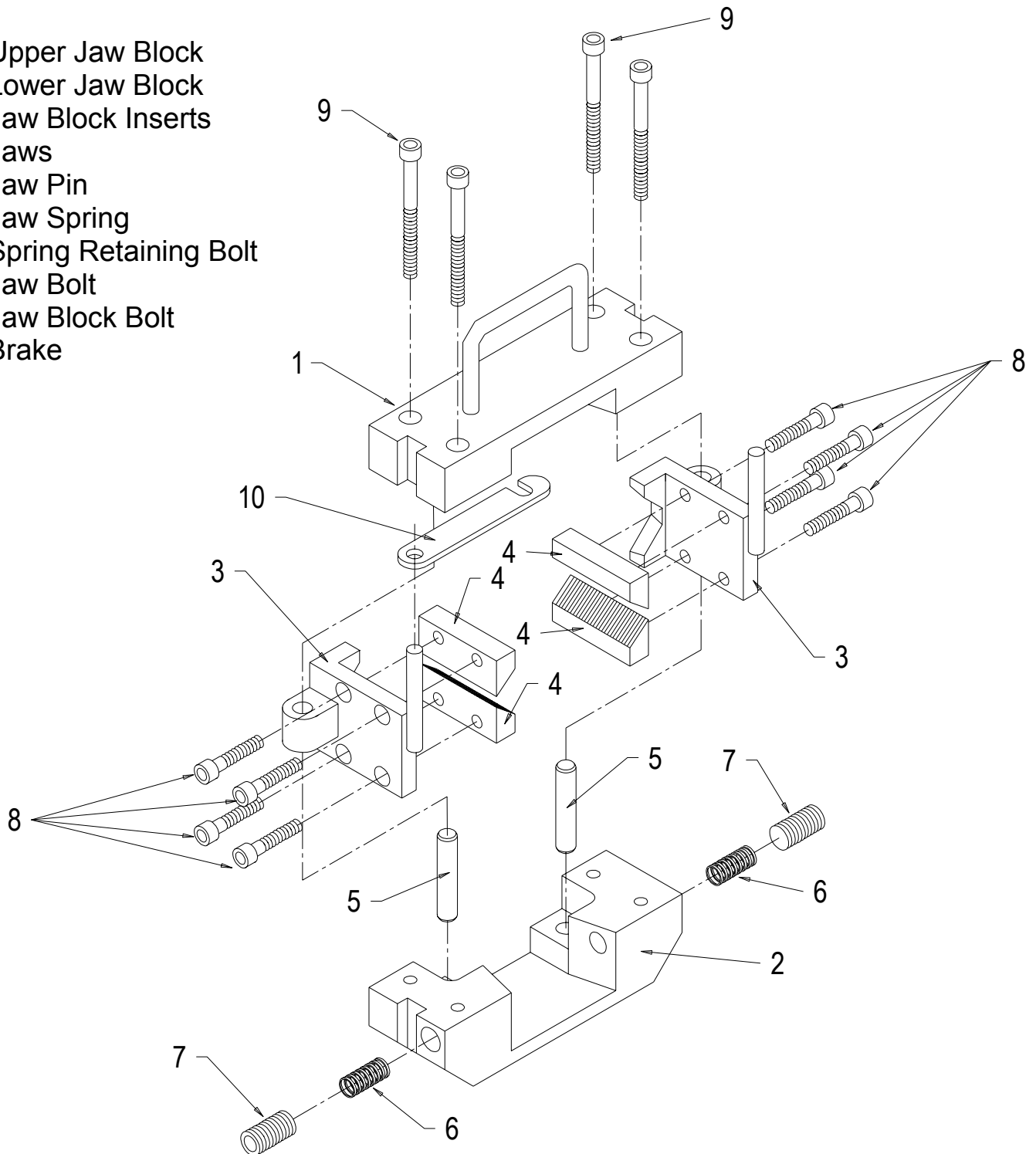

The company follow a policy of continuous product development and as such reserves the right to make alterations to equipment and techniques without prior notice.

PIPE EQUIPMENT SPECIALISTS LTD

66 DUKESWAY, TEESSIDE INDUSTRIAL ESTATE, THORNABY, STOCKTON-ON-TEES, TS17 9LT, ENGLAND

TEL: +44 (0) 1642 769789 FAX: +44 (0) 1642 769456

www.pipe-equipment.co.uk Email: info@pipe-equipment.co.uk



Certificate Number: 1253

WP/TIS/MAXJA4/109